

Scenic Designer:
Abigaile M. Wiker



Company:
PSCS
Centre Stage

Production:
Sylvia

Director:
Director

Scenic Designer:
Abigaile M. Wiker

Technical Director:
Technical Director

Plan:
Ground Plan

Sheet Number:
1
of: 8

Drawn By:
Abigaile M. Wiker

Scale:
1:4

Date:
9/20/16

Revision Date:
12/3/16

Advisor:
Dan Robinson

Notes:

Venue:
Pavilion Theatre
Address:
University Park

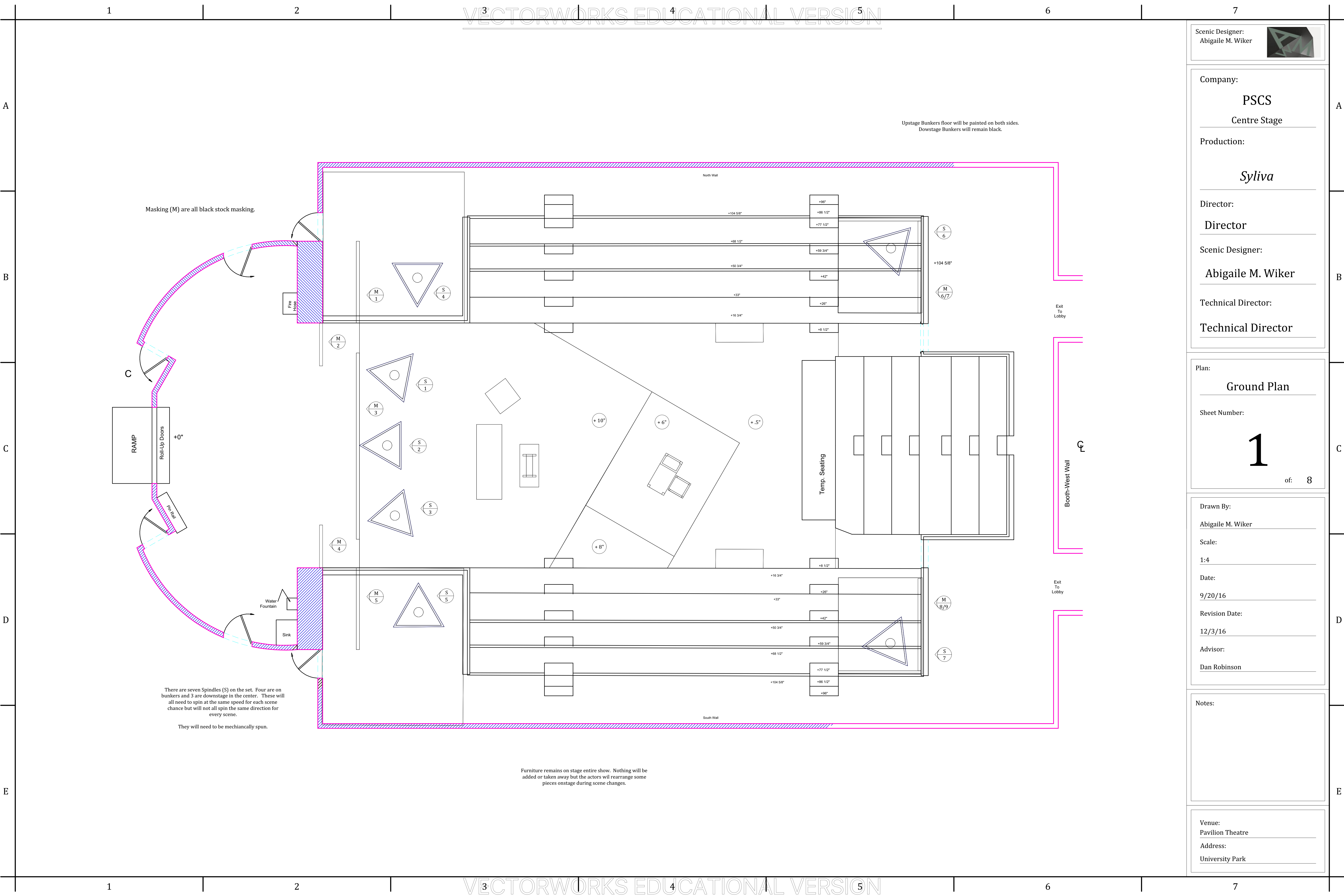

Masking (M) are all black stock masking.

Upstage Bunkers floor will be painted on both sides.
Dowstage Bunkers will remain black.

There are seven Spindles (S) on the set. Four are on bunkers and 3 are downstage in the center. These will all need to spin at the same speed for each scene chance but will not all spin the same direction for every scene.
They will need to be mechanically spun.

Furniture remains on stage entire show. Nothing will be added or taken away but the actors will rearrange some pieces onstage during scene changes.

Scenic Designer:
Abigaile M. Wiker



Company:
PSCS
Centre Stage

Production:
Sylvia

Director:
Director

Scenic Designer:
Abigaile M. Wiker

Technical Director:
Technical Director

Plan:
Side View

Sheet Number:
2
of: 8

Drawn By:
Abigaile M. Wiker

Scale:
1:4

Date:
9/20/16

Revision Date:
12/3/16

Advisor:
Dan Robinson

Notes:

Venue:
Pavilion Theatre
Address:
University Park

1 Overall Side View
Scale: 1/4" = 1'-0"

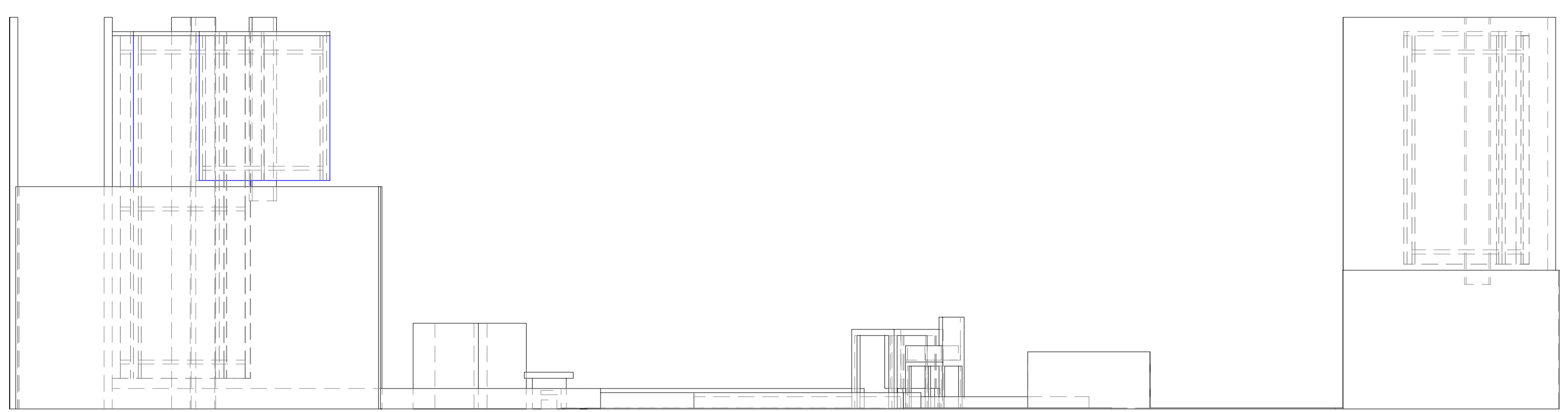

2 Side View w/o Drafting
Scale: 1/4" = 1'-0"

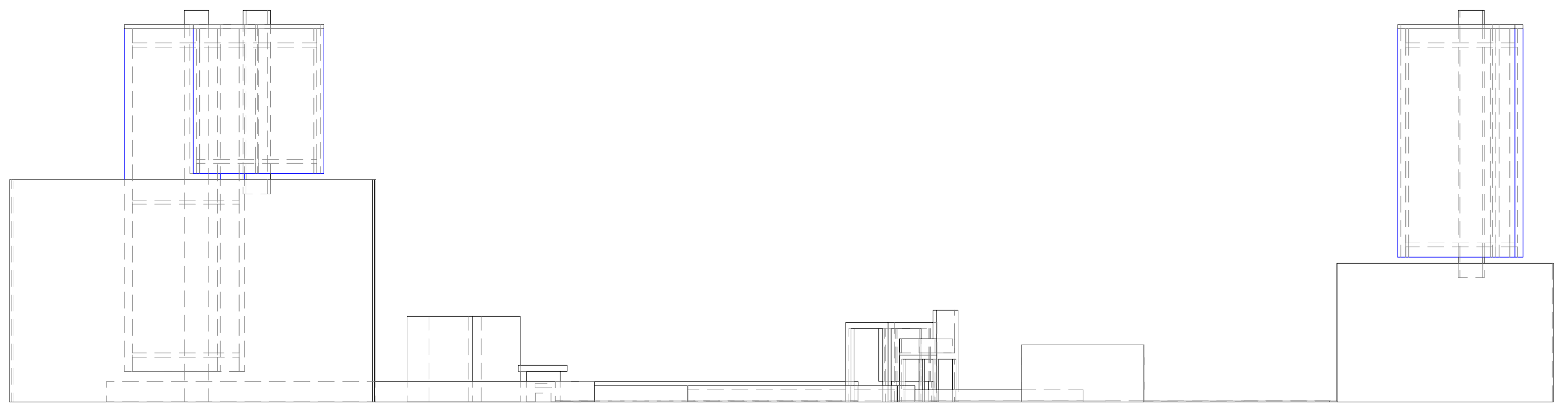

3 Rendered Side View
Scale: 1/4" = 1'-0"

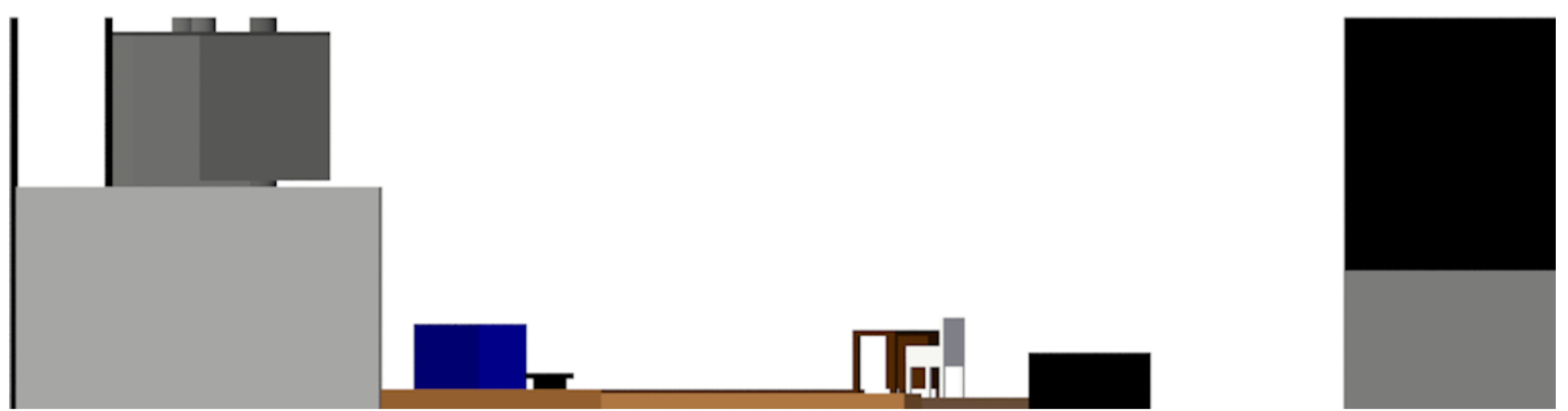

1

2

3

4

5

6

7

A

A

B

B

C

C

D

D

E

E

1

2

3

4

5

6

7

Scenic Designer:
Abigaile M. Wiker



Company:
PSCS
Centre Stage

Production:
Sylvia

Director:
Director

Scenic Designer:
Abigaile M. Wiker

Technical Director:
Technical Director

Plan:
Front View

Sheet Number:
3
of: 8

Drawn By:
Abigaile M. Wiker

Scale:
1:4

Date:
9/20/16

Revision Date:
12/3/16

Advisor:
Dan Robinson

Notes:

Venue:
Pavilion Theatre
Address:
University Park

1 Side View Overall
Scale: 1/4" = 1'-0"

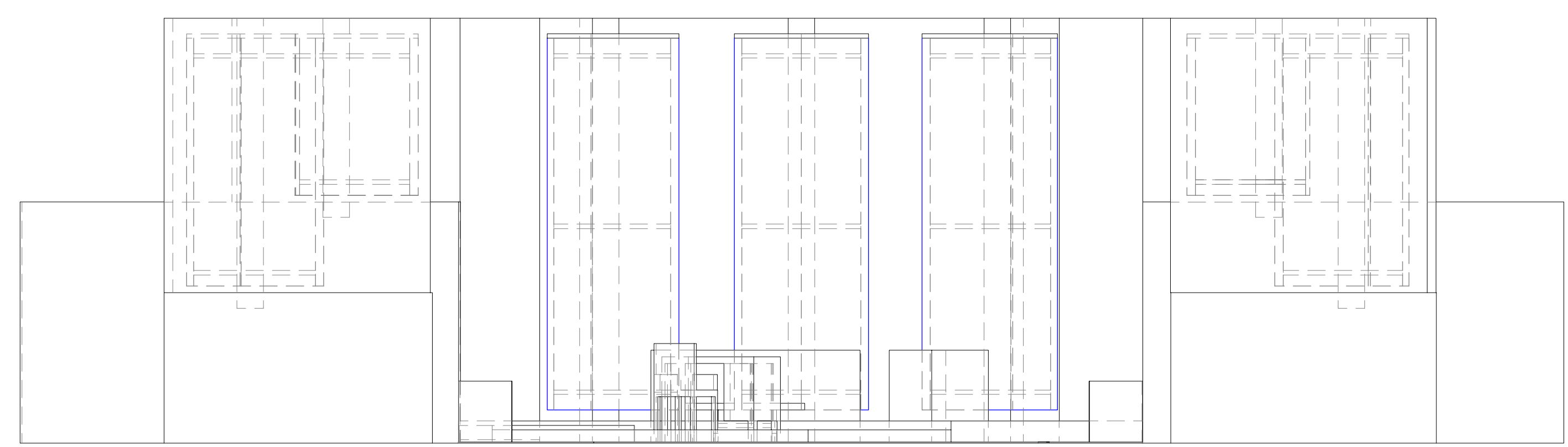

2 Side View w/o Masking
Scale: 1/4" = 1'-0"

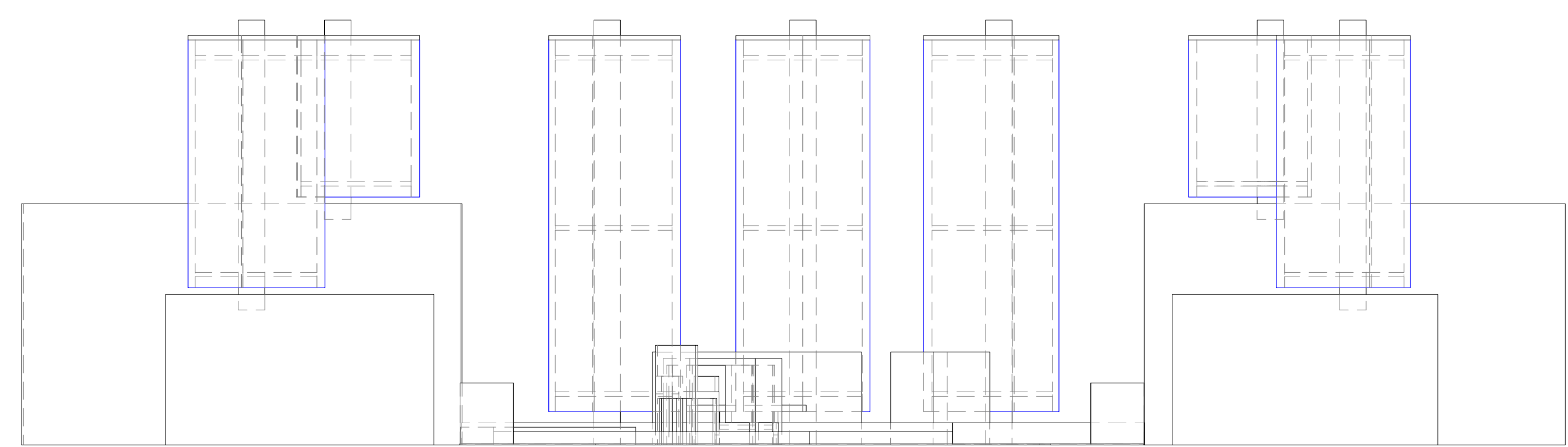

3 Rendered Side View
Scale: 1/4" = 1'-0"



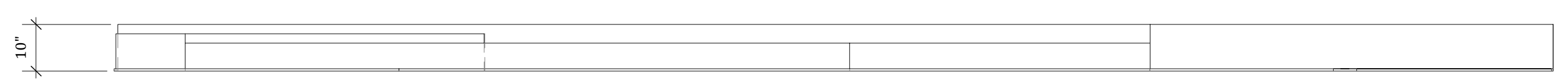
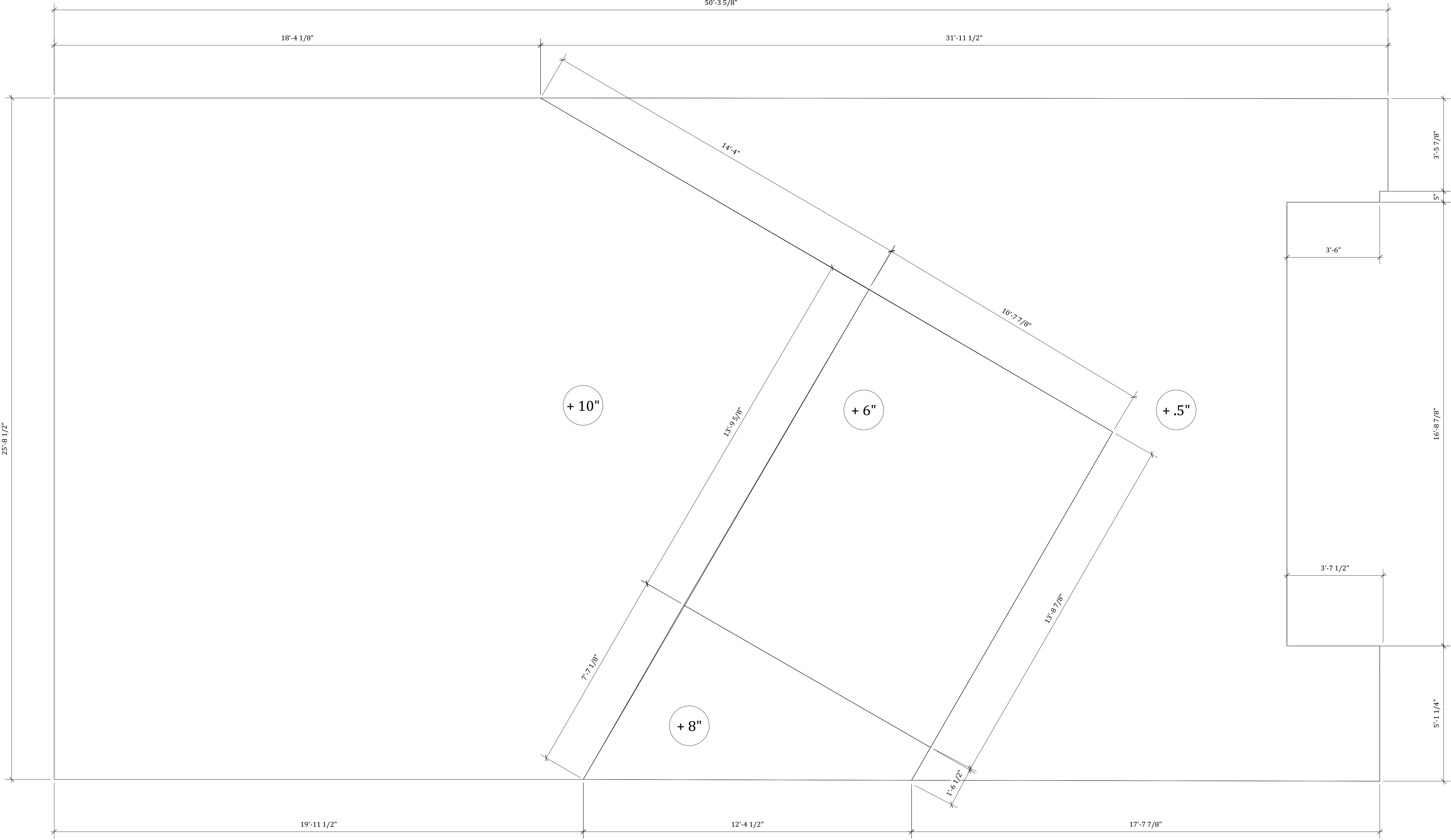

2 Front View
Scale: 1/2" = 1'-0"

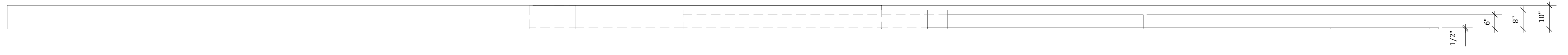

3 Side View
Scale: 1/2" = 1'-0"

Scenic Designer:
Abigaile M. Wiker



Company:
PSCS
Centre Stage

Production:
Syliva

Director:
Director

Scenic Designer:
Abigaile M. Wiker

Technical Director:
Technical Director

Plan:
Platforms & Deck

Sheet Number:
4
of: 8

Drawn By:
Abigaile M. Wiker

Scale:
1:4

Date:
9/20/16

Revision Date:
12/3/16

Advisor:
Dan Robinson

Notes:

Venue:
Pavilion Theatre
Address:
University Park

Scenic Designer:
Abigaile M. Wiker



Company:

PSCS

Production:

Syliva

Director:

Director

Scenic Designer:

Abigaile M. Wiker

Technical Director:

Technical Director

Plan:

Bunker Spindles

Sheet Number:

5

of: 8

Drawn By:

Abigaile M. Wiker

Scale:

Refer to Individuals

Date:

12/3/16

Revision Date:

12/3/16

Advisor:

Dan Robinson

Notes:

Venue:

Pavilion Theatre

Address:

University Park

1 Isometric View
Scale: 1/4" = 1'-0"

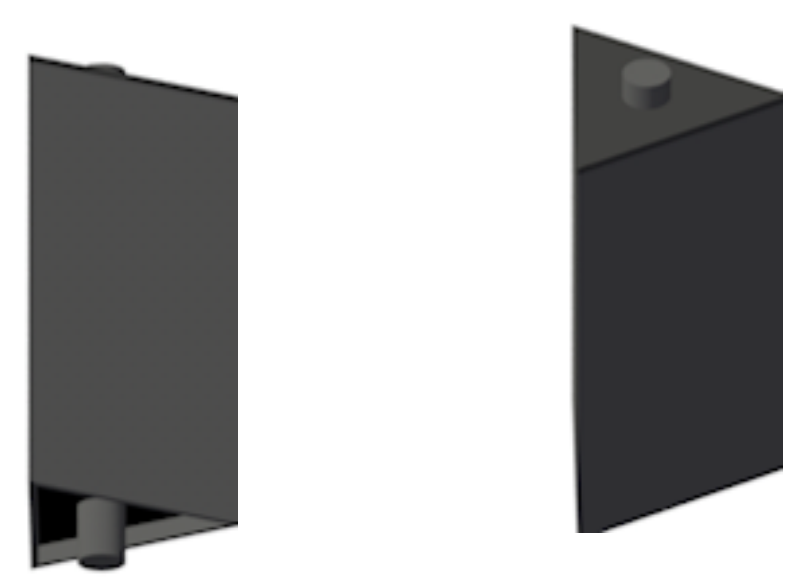

3 Bunker Spindles
Scale: 1/8" = 1'-0"

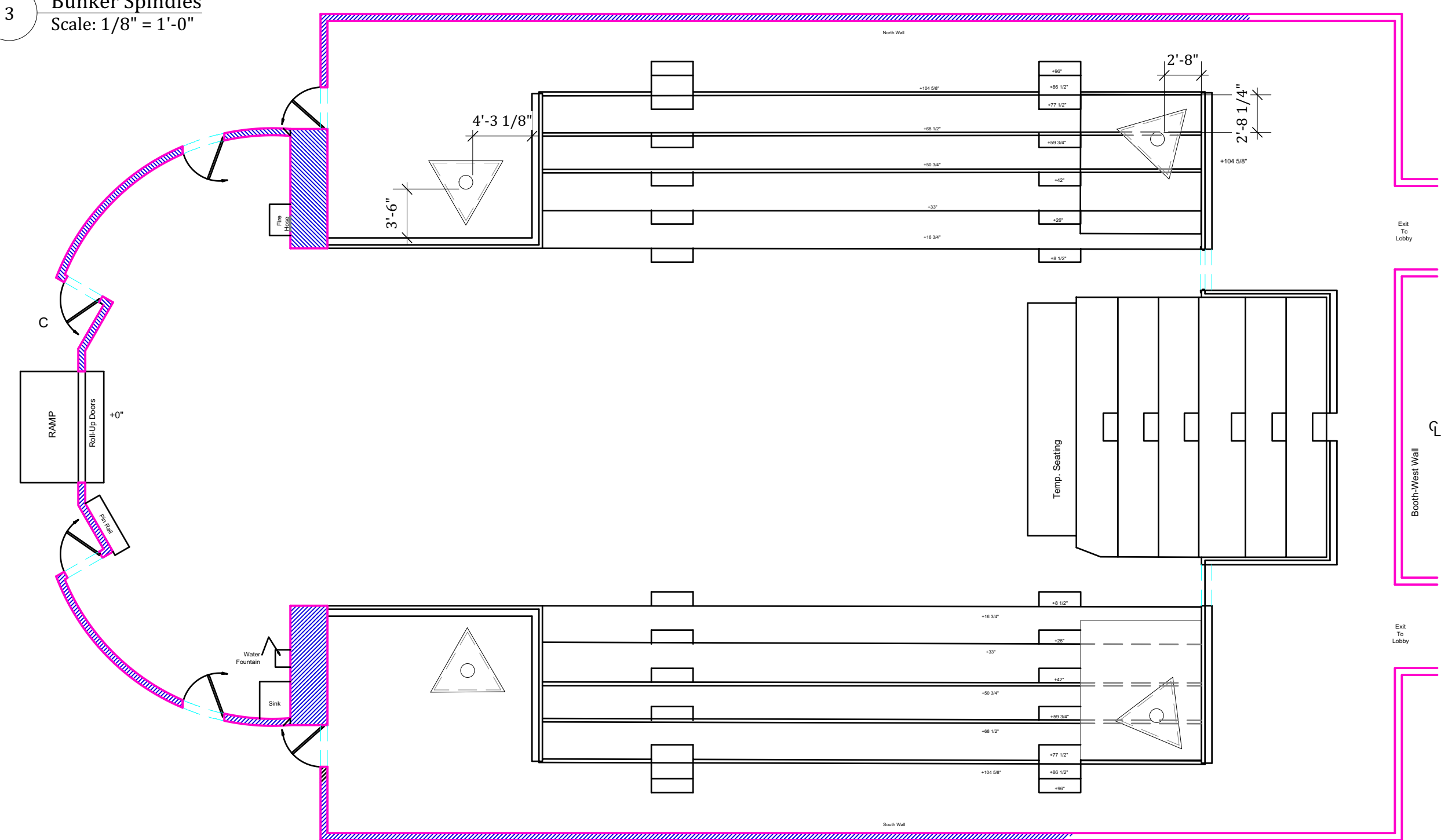

2 Isometric View
Scale: 1/4" = 1'-0"

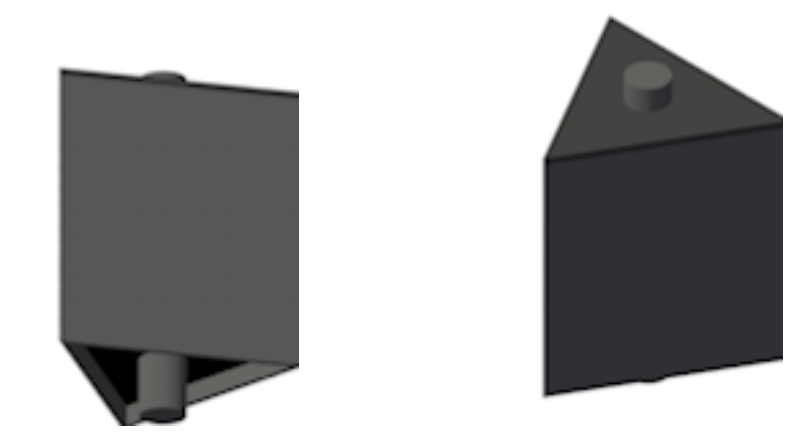

4 S1
Scale: 1/2" = 1'-0"

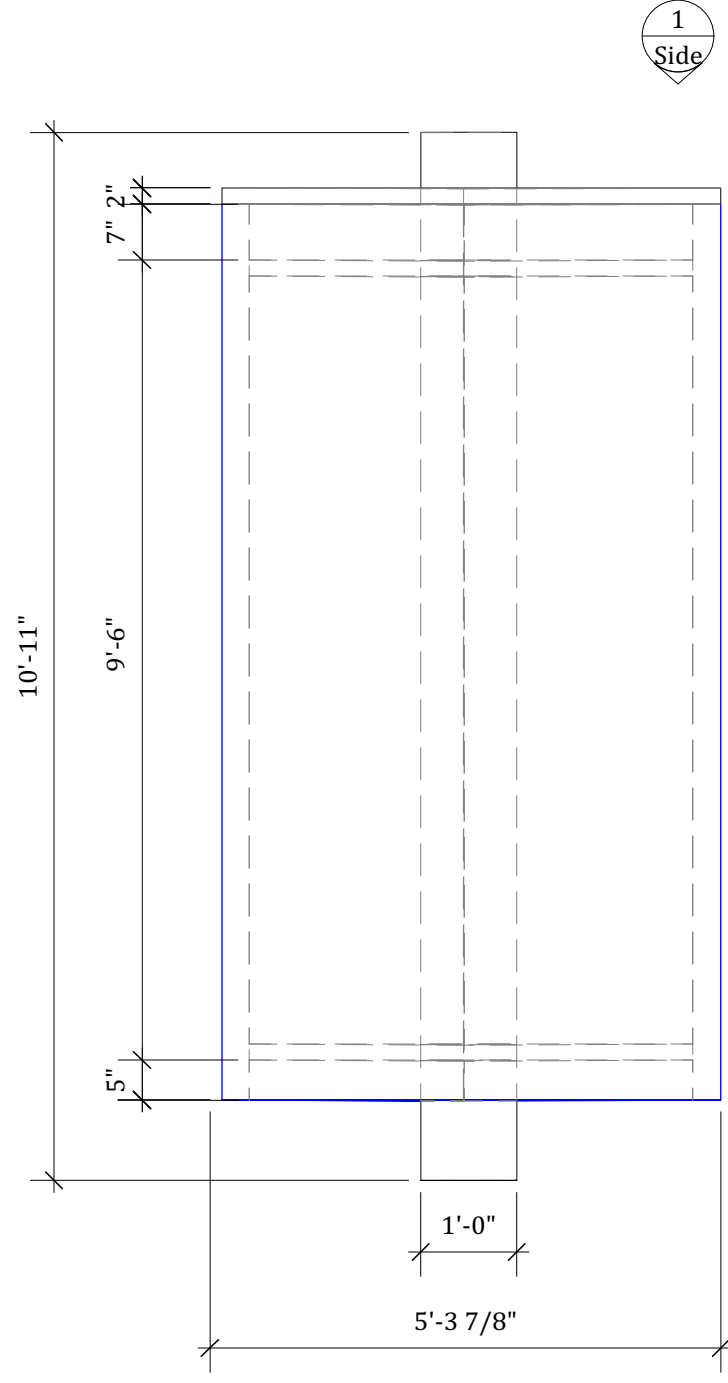

1 Side

2 Side

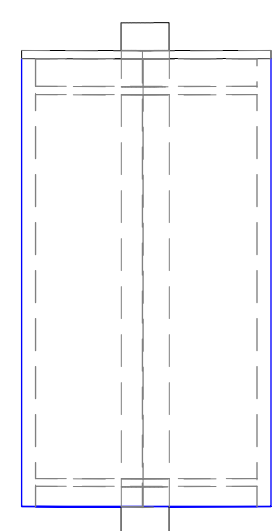

3 Side

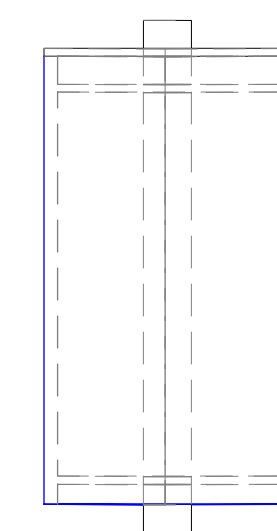

3 Side

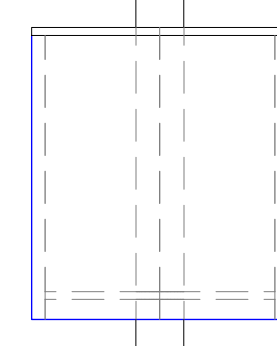

2 Side

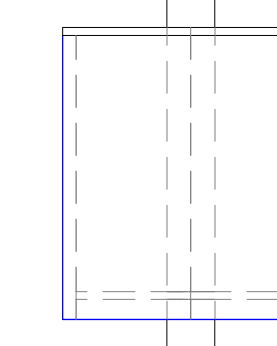

1 Side

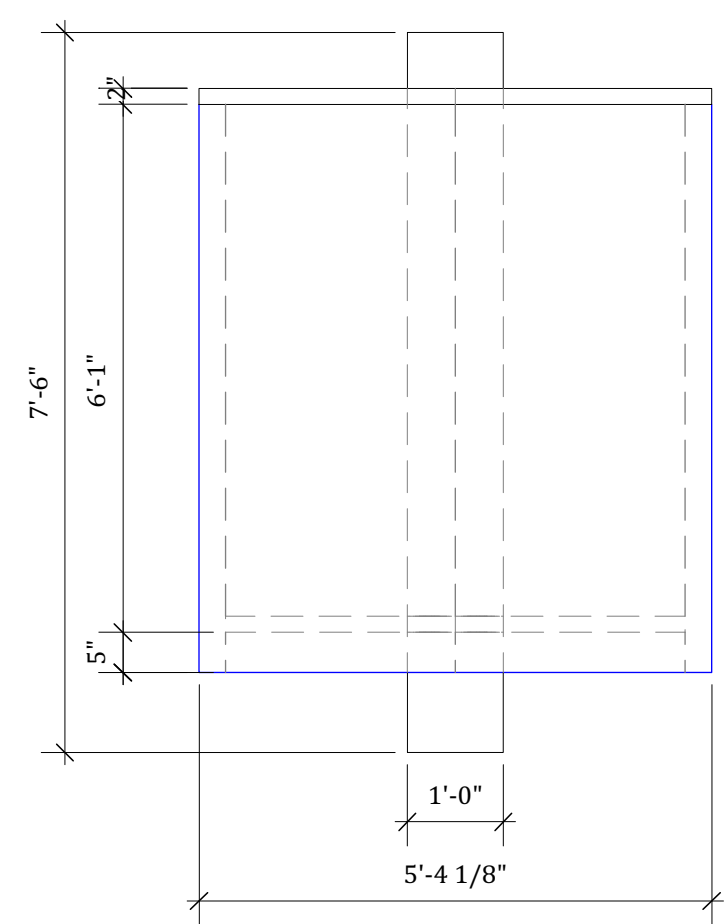

7 S6
Scale: 1/2" = 1'-0"

All spindles will have 1/4" plywood around the three sides. They will have images attached to the sides which will consist of large printed paper and glue.

5 S1 Top/Bottom
Scale: 1/2" = 1'-0"

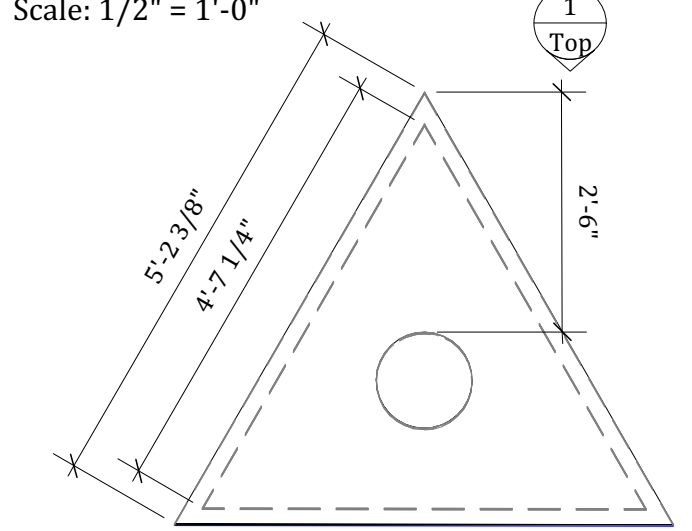

1 Top

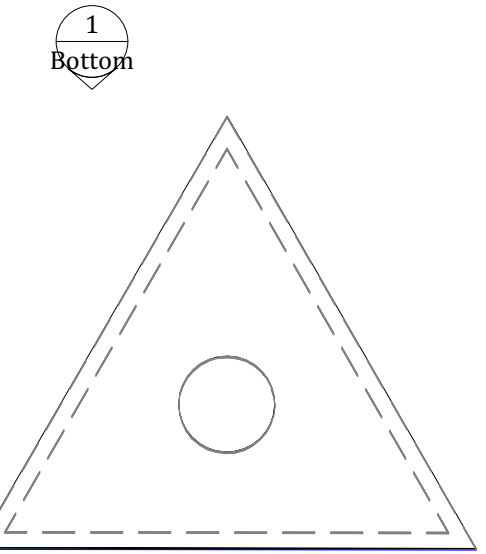

1 Bottom

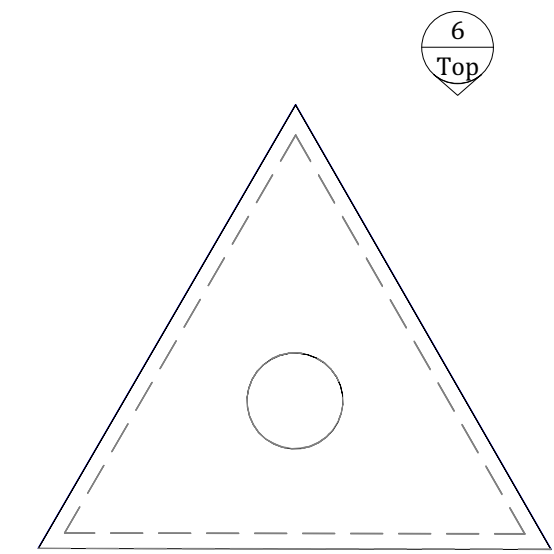

6 Top

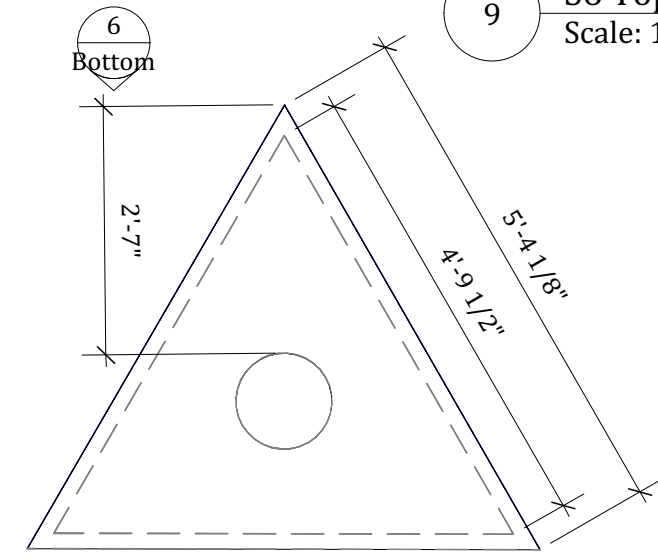

6 Bottom

9 S6 Top/Bottom
Scale: 1/2" = 1'-0"

6 S5
Scale: 1/4" = 1'-0"

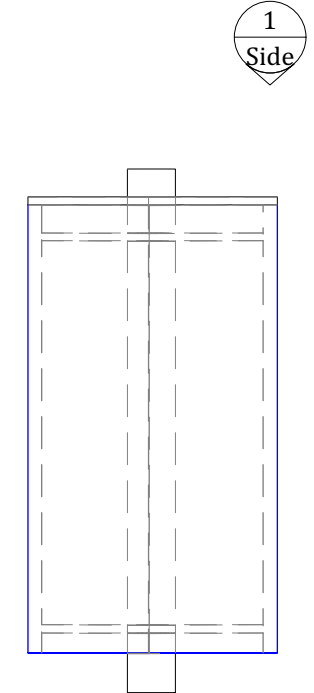

1 Side

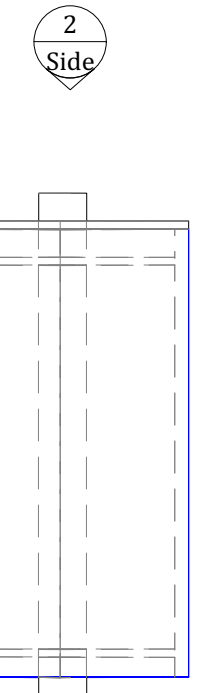

2 Side

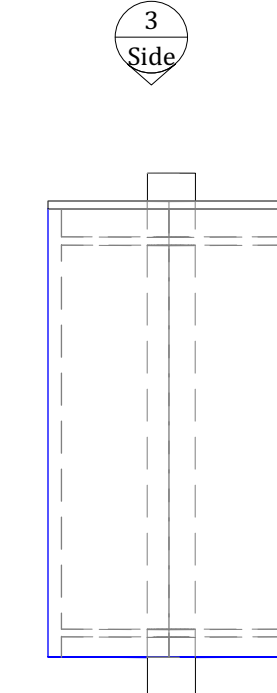

3 Side

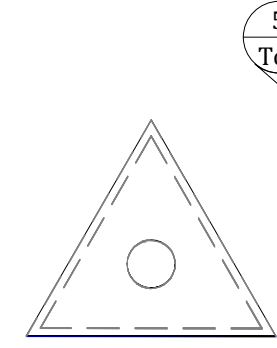

5 Top

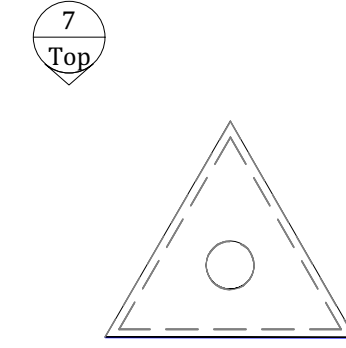

7 Top

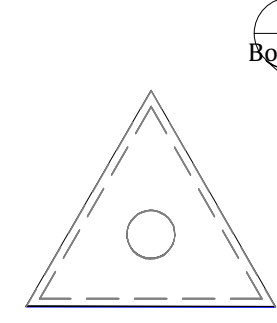

5 Bottom

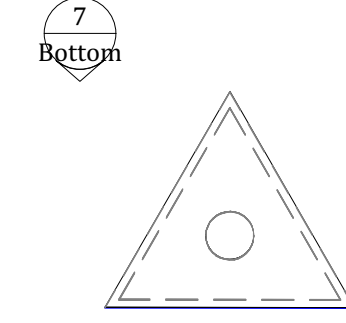

7 Bottom

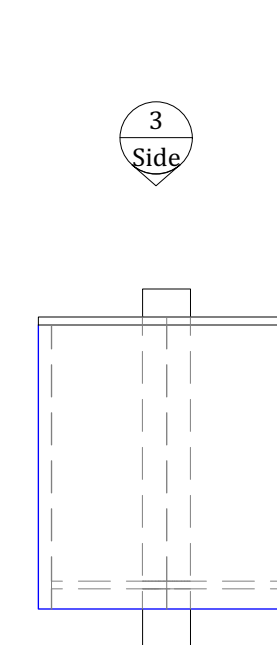

3 Side

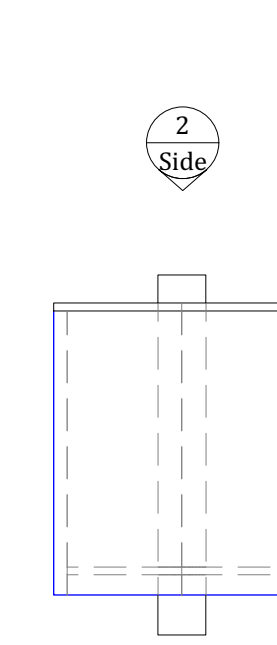

2 Side

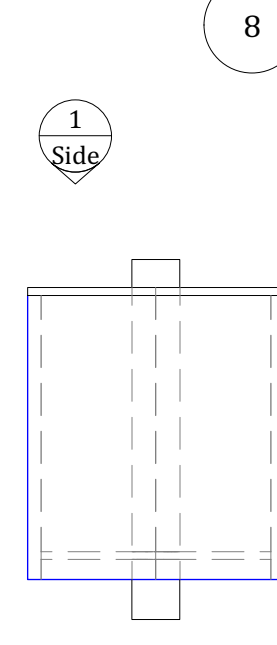

1 Side

8 S7
Scale: 1/4" = 1'-0"

Scenic Designer:
Abigaile M. Wiker



Company:

PSCS

Production:

Syliva

Director:

Director

Scenic Designer:

Abigaile M. Wiker

Technical Director:

Technical Director

Plan:

Spindles

Sheet Number:

6

of: 8

Drawn By:

Abigaile M. Wiker

Scale:

Refer to Individuals

Date:

12/3/16

Revision Date:

12/3/16

Advisor:

Dan Robinson

Notes:

Venue:

Pavilion Theatre

Address:

University Park

1 S2
Scale: 1/4" = 1'-0"

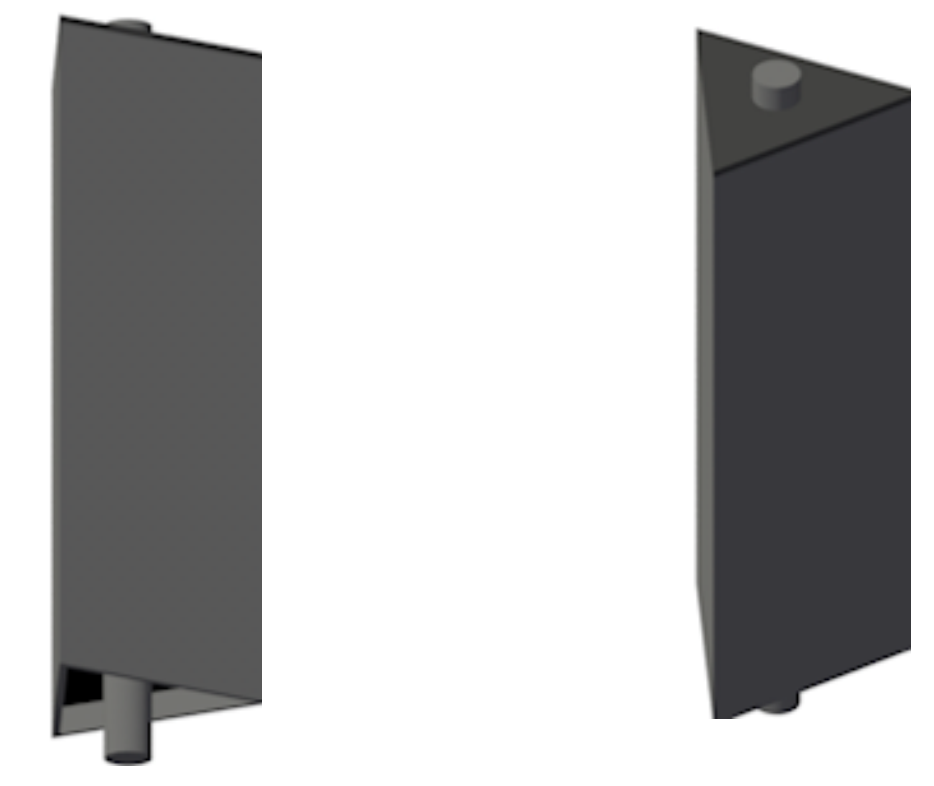

2 S2
Scale: 1/4" = 1'-0"

1 Side

2 Side

3 Side

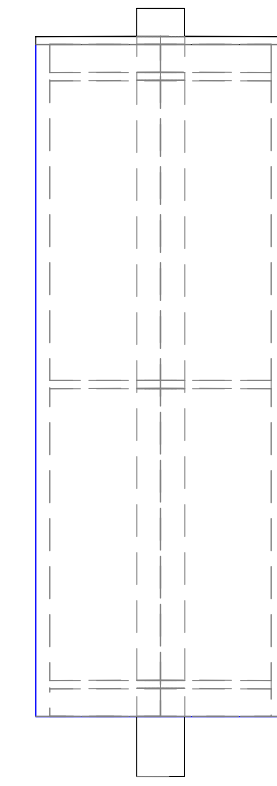
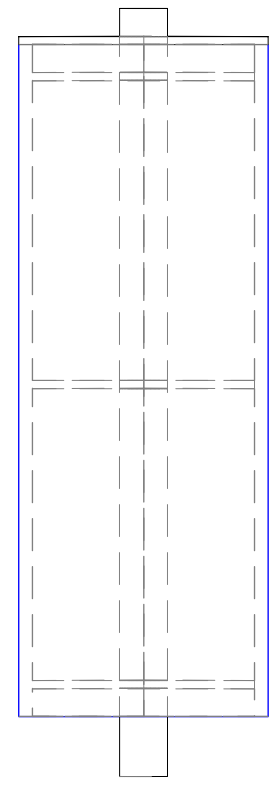
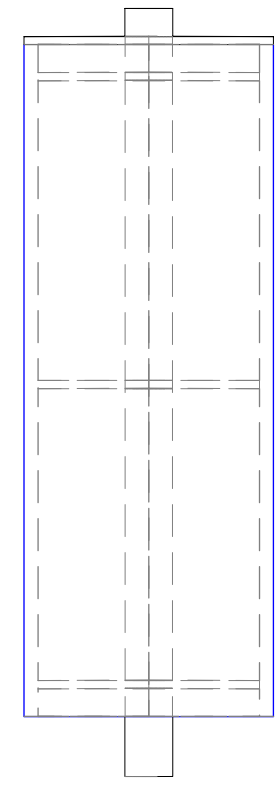

2 Top

3 Side

2 Side

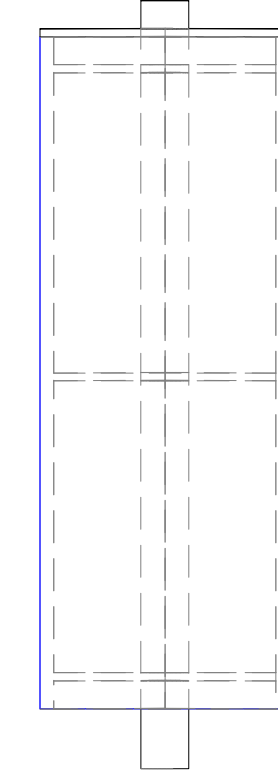
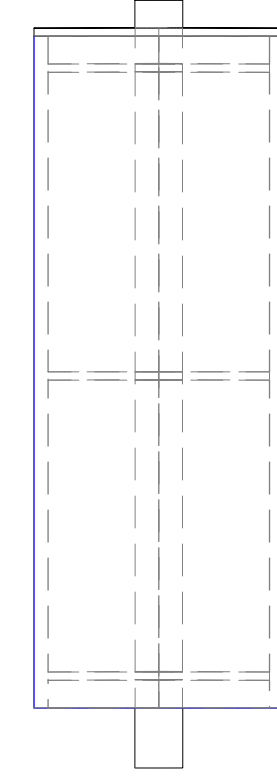
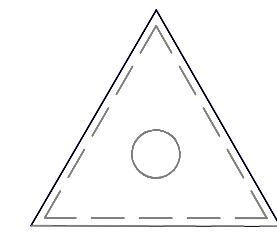

2 Bottom

4 S3
Scale: 1/4" = 1'-0"

1 Side

2 Side

3 Side

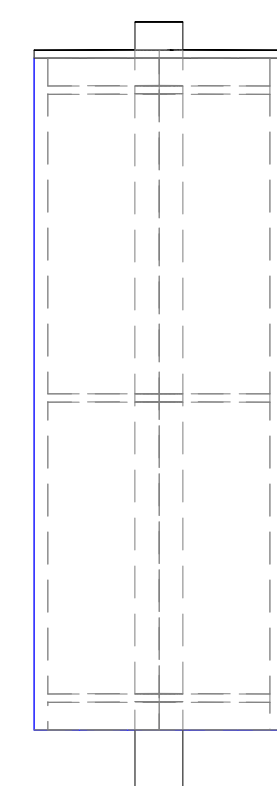
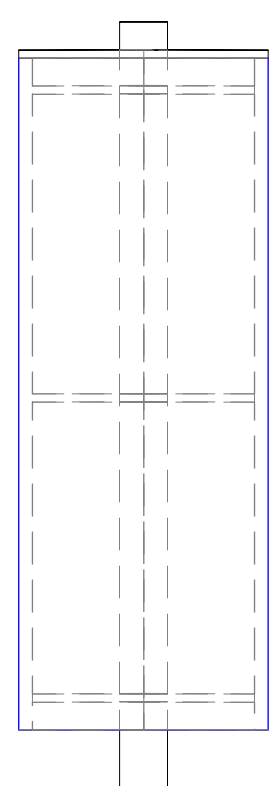
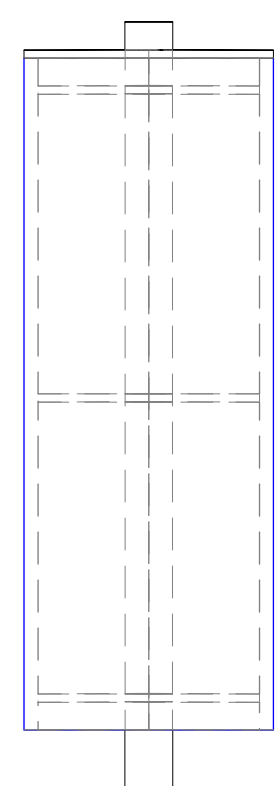

3 Top

4 Top

4 Bottom

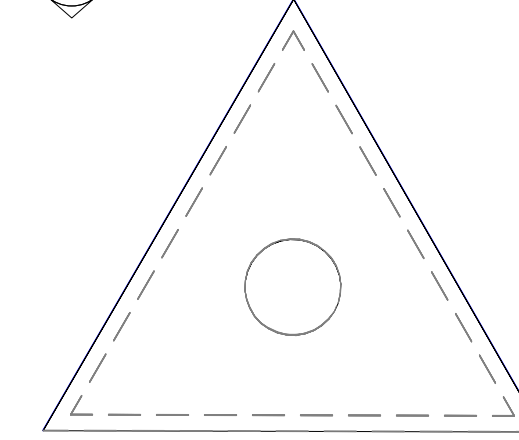
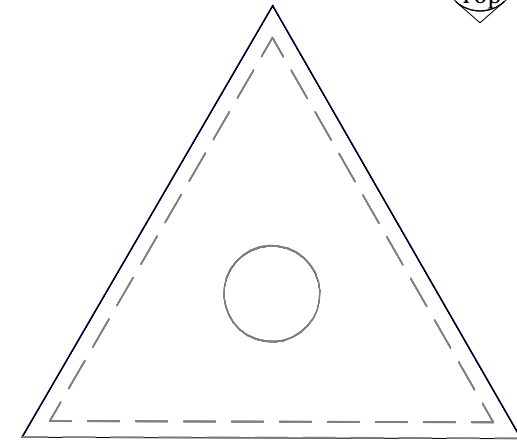
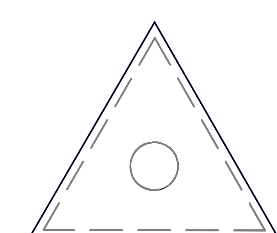

3 Bottom

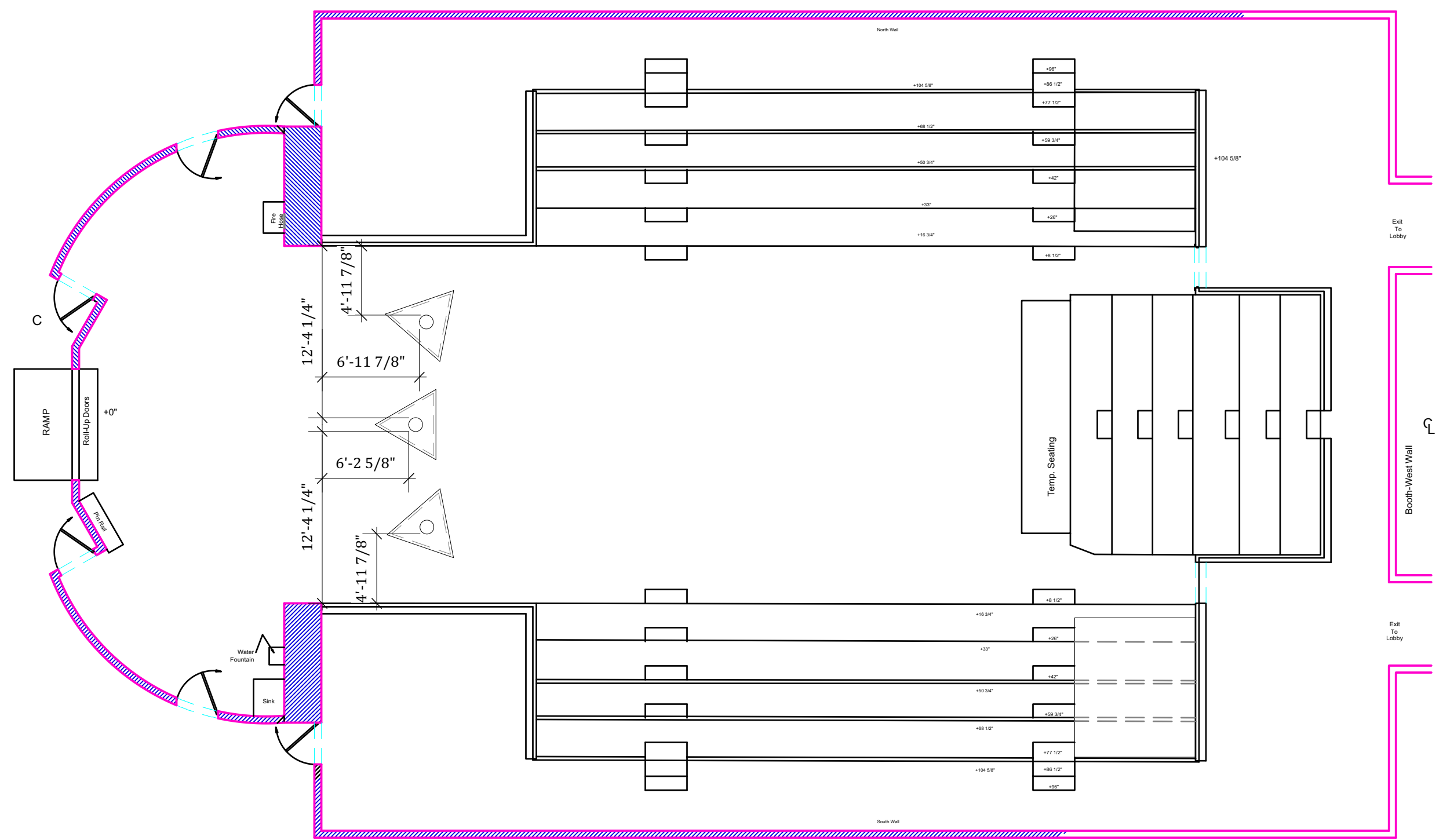

3 S4
Scale: 1/2" = 1'-0"

1 Side

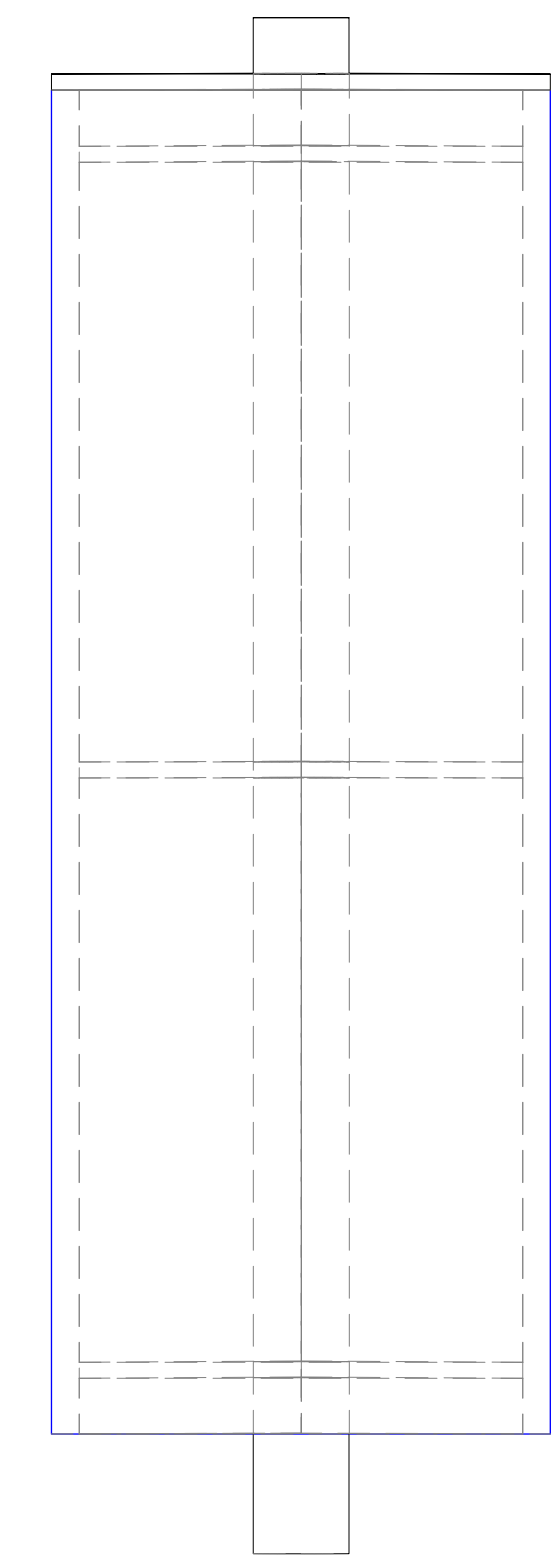

Scenic Designer:
Abigaile M. Wiker



Company:
PSCS

Production:
Syliva

Director:
Director

Scenic Designer:
Abigaile M. Wiker

Technical Director:
Technical Director

Plan:
Masking

Sheet Number:
7
of: 8

Drawn By:
Abigaile M. Wiker

Scale:
1:2

Date:
12/3/16

Revision Date:
12/3/16

Advisor:
Dan Robinson

Notes:

Venue:
Pavilion Theatre

Address:
University Park

1 Back Masking
Scale: 1/2" = 1'-0"

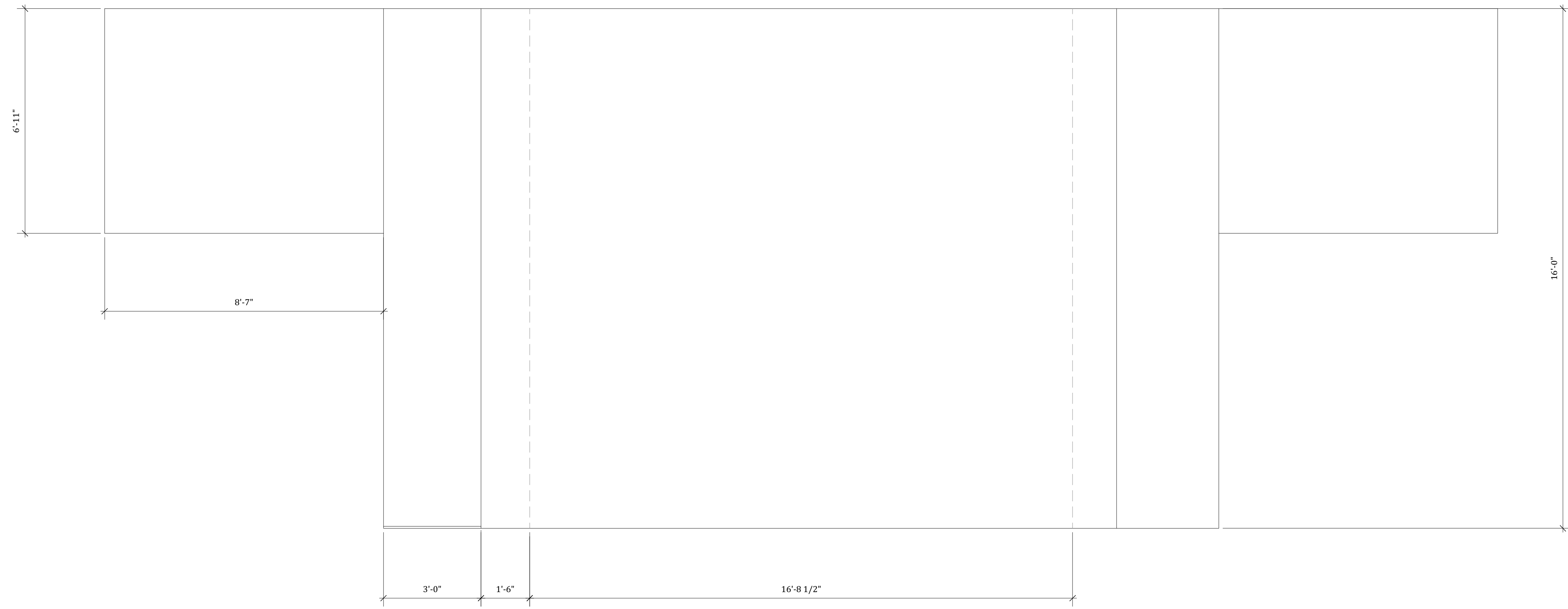

2 M3
Scale: 1/2" = 1'-0"

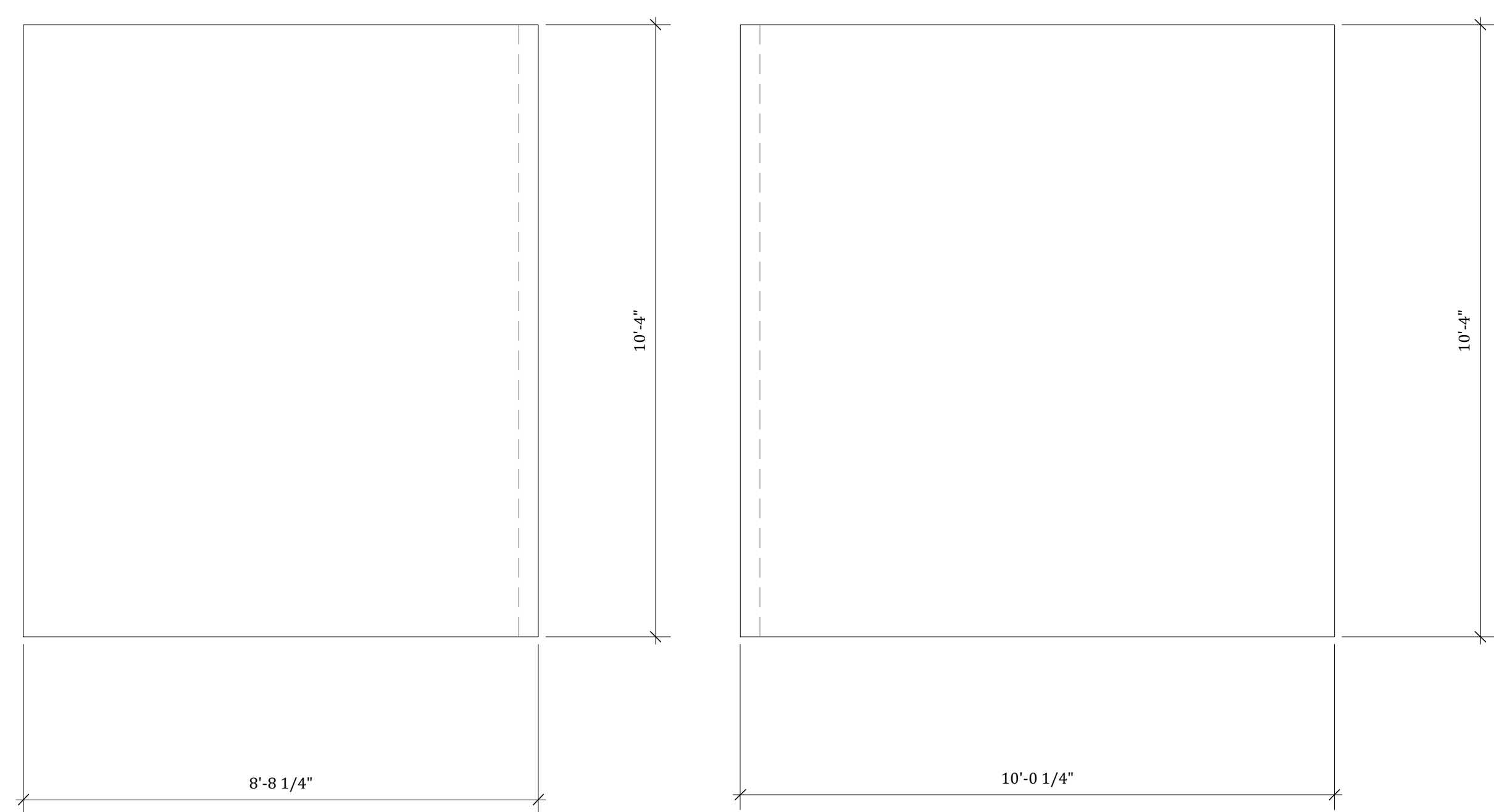

3 M2
Scale: 1/2" = 1'-0"

